



# ASRF4 圓角铣刀 Radius Mills (ASRF4)

內徑車刀

外徑車刀

牙刀 & 開槽刀

銑刀

搪孔刀

配件

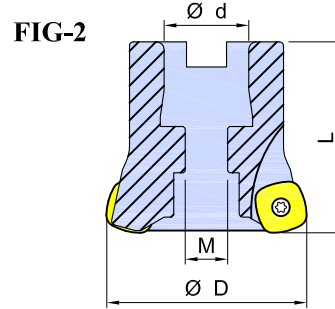
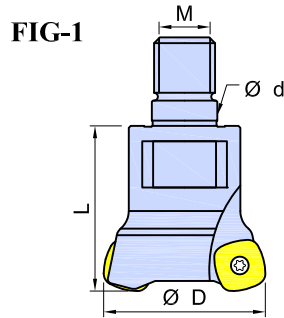
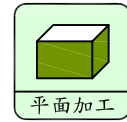
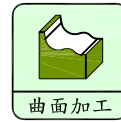
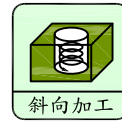



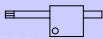

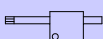
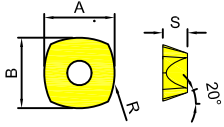
FIG-1 Ordering code	Dimensions,mm				Teeth	Insert	Screw 	Wrench 
	D	d	L	M				
ASRF4-353-MD29	35	17	43	M16	3	SD..1205..R15	MS4011G	TF15
ASRF4-424-MD29	42	17	43	M16	4			

FIG-2 Ordering code	Dimensions,mm				Teeth	Insert	Screw 	Wrench 
	D	d	L	M				
ASRF4-525-22.0	52	22.0	50	11	5	SD..1205..R15	MS4011G	TF15

Description	GRADE 材質 CY250	Insert Shape 	Dimensions,mm			
			A	B	S	R
SD..1205..R15	●		12.7	12.7	5.56	15